

M. SULIGA*

THE INFLUENCE OF THE HIGH SPEED MULTIPASS DRAWING PROCESS ON THE FATIGUE STRENGTH OF HIGH CARBON STEEL WIRES

WPLYW WIELOSTOPNIOWEGO PROCESU CIĄNIENIA Z DUŻYMI PRĘDKOŚCIAMI NA WYTRZYMAŁOŚĆ ZMĘCZENIOWĄ DRUTÓW ZE STALI WYSOKOWĘGLOWEJ

In this work the influence of the drawing speed on fatigue strength of high carbon steel wires has been assessed. The drawing process of $\varphi 5.5$ mm wires to the final wire of $\varphi 1.6$ mm was conducted in 11 passes, in industrial conditions, by means of a modern Koch multi-die drawing machine. The drawing speeds in the last passes were: 5, 10, 15 and 20 m/s. For $\varphi 1.6$ mm wires the investigation of fatigue strength has been carried out.

In order to explain the effect of drawing speed on fatigue strength of rope wires, the roughness of drawn wires have been also determined. In addition, the numerical analysis of the drawing process on the base of Drawing 2D in which distribution of redundant strain, has been shown.

The data of investigations prove the favourable effect of high drawing speed on fatigue strength of drawn wires. It was found that the better fatigue strength of wires drawn at the speed of 20 m/s compared to the wires drawn at the speeds of 5-15 m/s is associated with a better geometric structure of the surface of those wires. In addition to the high fatigue strength of the wires drawn with high speed is related to their higher redundant strain.

The obtained data investigation can be applied in wire industry while implementing the new technologies of high speed drawing process of high carbon steel wires.

Keywords: drawing speed, fatigue strength, rope wires, wire roughness

W pracy określono wpływ dużej prędkości ciągnięcia na wytrzymałość zmęczeniową drutów ze stali wysokowęglowej. Proces ciągnięcia drutów o średnicy 5,5 mm na średnicę końcową 1,60 mm zrealizowano w 11 ciągach, w warunkach przemysłowych, na nowoczesnej cięgarni wielostopniowej Kocha. Prędkości ciągnięcia na ostatnim ciągu wynosiły odpowiednio: 5, 10, 15 i 20 m/s. Badania wytrzymałości zmęczeniowej przeprowadzono dla drutów końcowych $\varphi 1,60$ mm.

Dla pełniejszej oceny wpływu wielkości prędkości ciągnięcia na wytrzymałość zmęczeniową drutów liniarskich przeprowadzono także badania chropowatości powierzchni. Dodatkowo w pracy, w oparciu o program Drawing 2d, przeprowadzono analizę numeryczną procesu ciągnięcia, w której określono odkształcenia postaciowe w drutach po procesie ciągnięcia.

Uzyskane wyniki badań świadczą o korzystnym wpływie dużej prędkości ciągnięcia na wytrzymałość zmęczeniową drutów. Stwierdzono, że lepsza wytrzymałość zmęczeniowa drutów ciągniętych z prędkością 20 m/s, w stosunku do drutów ciągniętych z prędkościami 5-15 m/s, związana jest z ich lepszą strukturą geometryczną powierzchni oraz większymi odkształceniami postaciowymi.

Uzyskane wyniki badań mogą być wykorzystane w przemyśle cięgarnym przy wdrażaniu nowych technologii szybkiego ciągnięcia drutów ze stali wysokowęglowych.

1. Introduction

Drawing technology plays an important role in developing the properties of wires drawn. The basic technological parameters influencing the properties of drawn wires include drawing speed. Although some studies on the effect of high drawing speed on the drawing process parameters and the mechanical and technological prop-

erties of wires can be found in literature, there are few studies dealing with the influence of this parameter on the fatigue strength of high-carbon steel wires [1÷3]. These wires are used for manufacturing ropes, springs and cord, that is metal products from which particularly high fatigue strength is required. Wire fatigue strength is the resistance of the wire to bending stresses that act upon it.

* CZESTOCHOWA UNIVERSITY OF TECHNOLOGY, FACULTY OF MATERIAL PROCESSING TECHNOLOGY AND APPLIED PHYSICS, INSTITUTE OF PLASTIC FORMING AND SAFETY ENGINEERING, 42-200 CZESTOCHOWA, 19 ARMII KRAJOWEJ STR., POLAND

Wire fatigue strength is influenced by a number of factors that may include: the type of drawing die, lubrication conditions, drawing direction, the structure of steel, residual stresses, surface texture, mechanical properties and the hardening of the wire sub-surface layer [4÷7].

In connection with the above, the effect of the high-speed multi-stage drawing process on the fatigue strength of high-carbon steel wires was determined in the study.

2. Material and applied drawing technologies

The material used to the investigation was C72DP high carbon steel wire rod (0.72%C). The chemical composition of C72DP steel is presented in Table 1.

TABLE 1
The chemical composition of C72DP steel

Element contain, %									
C	Mn	Si	P	S	Cr	Ni	Cu	Al	N
0.74	0.61	0.23	0.009	0.013	0.04	0.02	0.03	0.003	0.0036

Before drawing, wire rod was patented, itched and boraxed. The structure of wire rod after patenting is presented on Fig. 1.

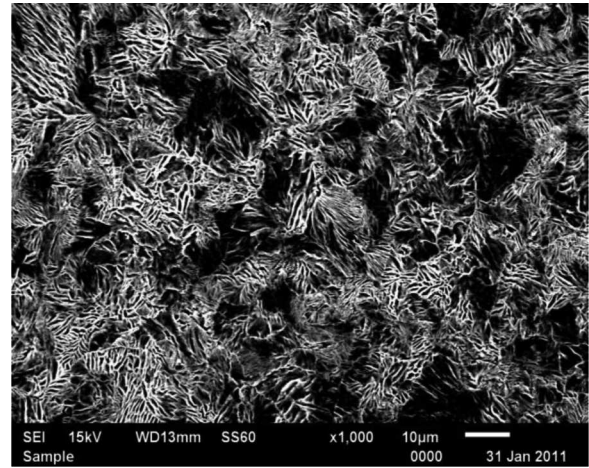

Fig. 1. Microstructure of wire rod after patenting, nital etching

The drawing process of 5.5 mm wires on the final wire 1.6 mm was conducted in 11 passes, in industrial conditions, by means of a modern Koch multi-die drawing machine. The drawing speeds on the last passes were: variant A → 5 m/s, variant B → 10 m/s, variant C → 15 m/s, variant D → 20 m/s.

Single reduction of area, D_s , and total reduction of area, D_t , are summarized in Tables 2 while drawing speeds on single reductions for wires from variant A÷D are presented in Table 3 and on Fig. 2. In drafts 1÷4 was applied CONDAT Vicafil SUMAC 2T lubricant while in drafts 5÷11 TRAXIT SL 202 BS lubricant.

TABLE 2
Distribution of single and total reduction of area for wires from variant A÷D

Draft number	0	1	2	3	4	5	6	7	8	9	10	11
φ , mm	5.50	4.92	4.38	3.90	3.50	3.12	2.80	2.50	2.22	2.00	1.78	1.60
D_s , %	–	19.98	20.75	20.72	19.46	20.54	19.46	20.28	21.15	18.84	20.79	19.20
D_t , %	–	19.98	36.58	49.72	59.50	67.82	74.08	79.34	83.71	86.78	89.53	91.54

TABLE 3
Drawing speeds (V, m/s) for variant A÷D

Variant	Draft number										
	1	2	3	4	5	6	7	8	9	10	11
A	0.53	0.67	0.84	1.05	1.32	1.63	2.05	2.60	3.20	4.04	5
B	1.06	1.34	1.69	2.09	2.63	3.27	4.10	5.20	6.40	8.08	10
C	1.59	2.00	2.53	3.14	3.95	4.90	6.14	7.80	9.60	12.12	15
D	2.12	2.67	3.37	4.18	5.26	6.53	8.19	10.39	12.80	16.16	20

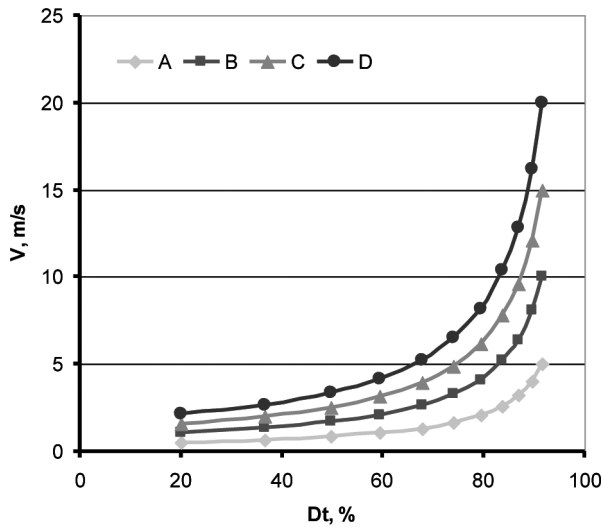

Fig. 2. Drawing speeds in total reduction function for wires from variant A÷D

3. Fatigue strength testing

Fatigue tests of wires were carried out on a testing machine modelled on the schematic of the PUL DRABI SCHENCK testing machine. A schematic diagram of the testing machine is shown in Fig. 3.

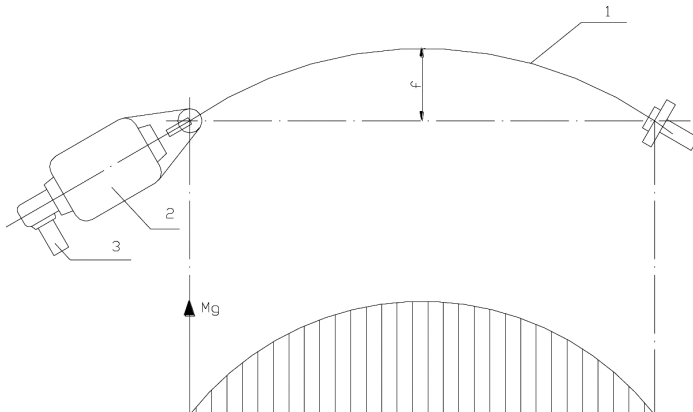

Fig. 3. Schematic diagram of the testing machine used for wire fatigue strength tests and the distribution of bending moments M_g within the wire tested; 1 - wire, 2 - motor, 3 - revolution counter, f - deflection

The wires fatigue tests were conducted under the rotary bending conditions, as the testing machine enables a symmetric fatigue cycle to be obtained, while the variable-sign maximum bending stress in the outer wire layers was calculated from formula (1) by substituting in the formula the actual value of Young's modulus, as determined from the tensile tests performed on the

testing machine. In these tests, the number of cycles (N) completed until a wire break was determined.

$$\sigma_{\max} = \pm \frac{6 \cdot f \cdot d \cdot E}{l^2} \quad (1)$$

where: f - deflection, d - wire diameter, E - Young's modulus, l - specimen length.

The temporal (time-limited) fatigue strength, z_g , allowing the determination of the Wöhler curves, was determined for final $\varphi 1.6$ mm-diameter wires, for drawing variants A, B, C and D, while applying six different levels of bending stress, σ_{\max} .

The results of the high-carbon steel wire fatigue strength tests are shown in Table 4.

TABLE 4
The average values of the number of fatigue cycles (N) completed until the break of wires drawn according to variants A÷D for different levels of bending stress σ_{\max}

σ_{\max} , MPa	The number of cycles to a wire break (N)			
	A	B	C	D
1031.3	7200	6866	8532	14384
937.5	9866	9946	11260	18066
843.8	15844	15140	18350	28410
750.0	19176	18004	21756	35112
656.3	24680	24314	26760	48080
562.5	34028	34764	40386	60326

Based on the results given in Table 4, a wire fatigue strength diagram was plotted for different drawing variants, Fig. 4. This enabled the assessment of the effect of drawing speed and the maximum (variable) wire bending stress on the temporal fatigue strength of the wire.

Then, the obtained results were approximated with a function of two variables, as represented by relationship (2) in the following form:

$$N = 107400 - 78.4V + 131.8V^2 - 173.4\sigma_{\max} + 0.1\sigma_{\max}^2 - 2.8V\sigma_{\max} \quad (2)$$

where: N - number of cycles to a wire break, V - drawing speed, σ_{\max} - maximum bending stress.

To better illustrate the effect of drawing speed on the wire fatigue strength, based on the approximating function (2), a graph was plotted, which defined the variation of the number of cycles N to a wire break depending on drawing speed, while assuming the maximum wire bending stress of $\sigma_{\max} = 500$ MPa (Fig. 5).

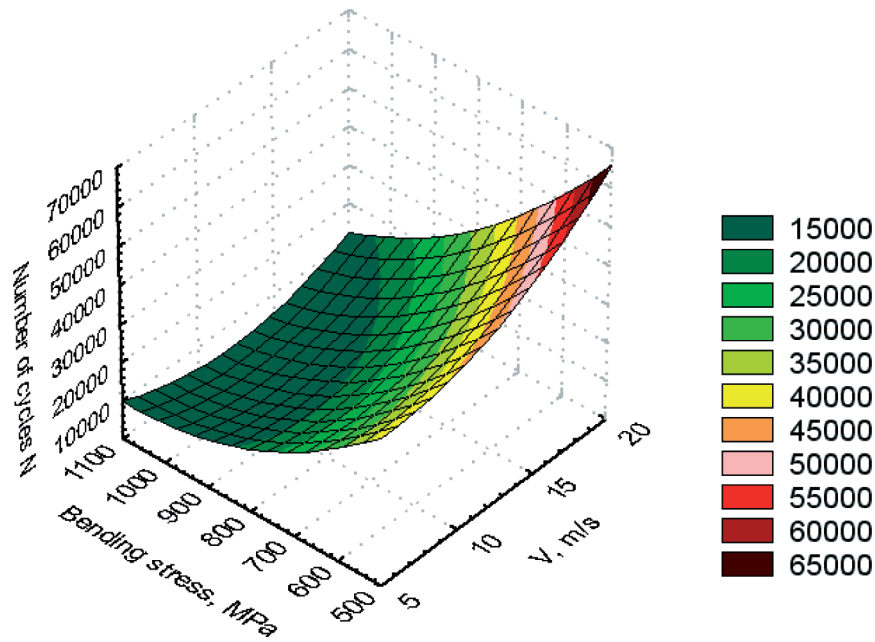

Fig. 4. Diagrams of temporal fatigue strength as dependent on the drawing speed and bending stress for $\varphi 1.60$ mm wires drawn according to variants A÷D

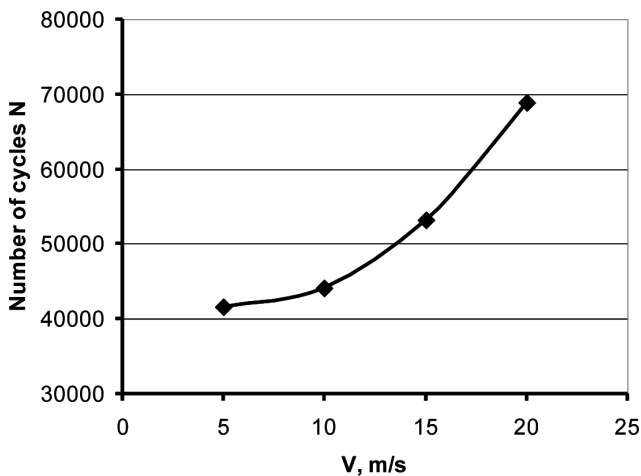

Fig. 5. The changing of the number of fatigue cycles (N) completed until the break of wires in dependence of drawing speed, by $\sigma_{max} = 500$ MPa

It can be found from the results in Figs. 4-5 that drawing speed has a great effect on the fatigue strength of high-carbon steel wires. The performed tests showed that with the increase in drawing speed the wire fatigue strength increased. At the same time, in the drawing speed range of 5÷10 m/s the differences between the testing variants were small, whereas at drawing speed above 15 m/s the differences between the variants were already significant. For example, increasing the drawing speed from 5 m/s (Variant A) to 20 m/s (Variant D), at a bending stress of 562.5 MPa, caused an increase

in the fatigue strength of the D Variant wires by 77.3% compared to the Variant A wires.

As the group of factors significantly influencing the achieved wire fatigue strength level includes the wire surface texture, the effect of drawing speed on wire surface roughness was determined in the study.

4. Surface roughness of wires after the drawing process

The examination of changes in the surface texture of high-carbon steel wires was carried out on a Form Talysurf Series profilometer. To illustrate the effect of drawing speed on the surface roughness, the following parameters were selected for analysis:

- profile height parameters: $R_p, R_v, R_t, R_{pm}, R_{vm}$,
- profile deviation parameter: R_a, R_q, R_{sk}
- horizontal profile parameter: S, S_m
- Newman's ratio: S/R_{vm} .

The wire roughness measurement was performed for final $\varphi 1,6$ mm-diameter wires. In the examination of wire surface roughness, the measuring length, L, was equal to 5 elementary sections, each being 0.8 mm long ($L=4.0$ mm). Figure 6 shows an example profilogram of the surface of wires drawn following Variant A. The results of the surface roughness examinations of wires from Variants A÷D are illustrated in Figs. 7÷10.

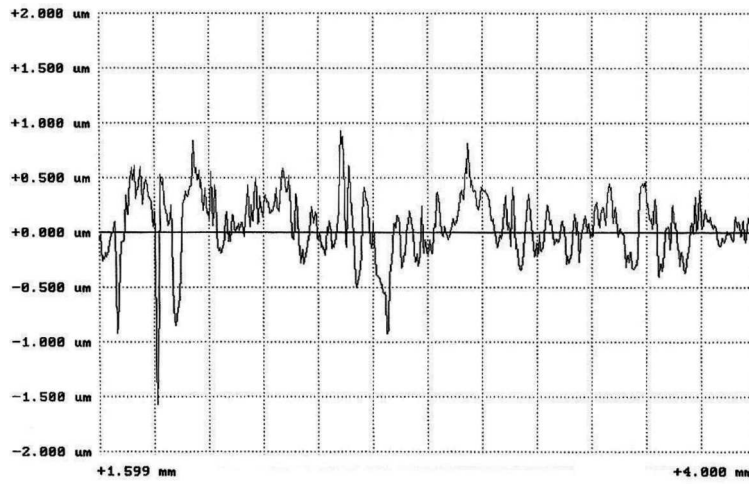

Fig. 6. A profilogram of the surface of $\varphi 1.20$ mm wires (Variant A) along the measuring length

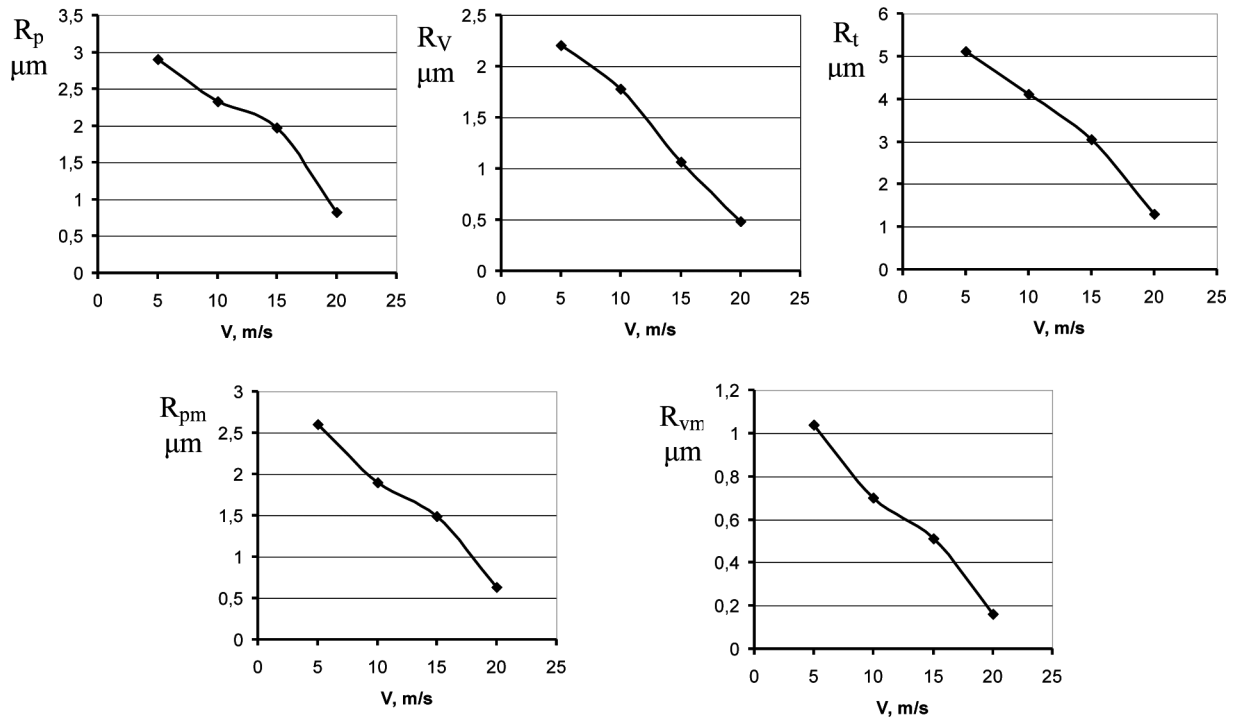

Fig. 7. The changing of value of the profile height parameters of the surface roughness of wires of diameters of $\varphi 1.6$ mm drawn in drawing speed function

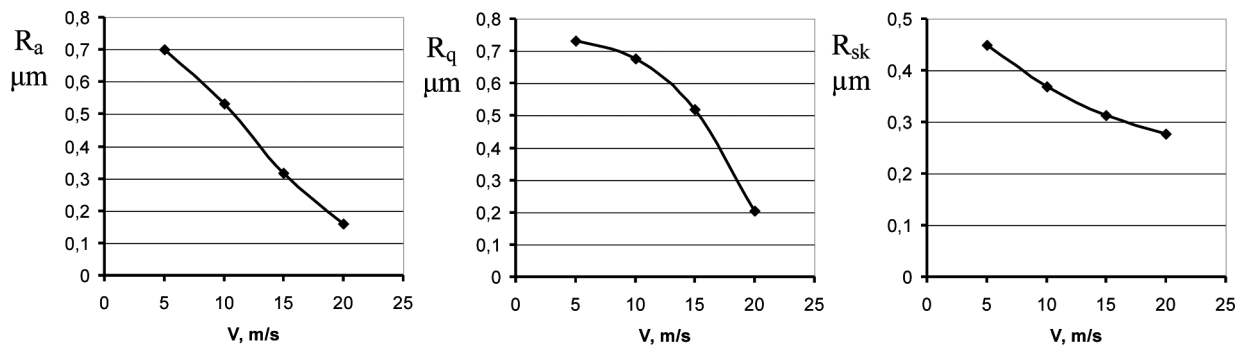

Fig. 8. The changing of value of the profile deviation parameter of the surface roughness of wires of diameters of $\varphi 1.6$ mm drawn in drawing speed function

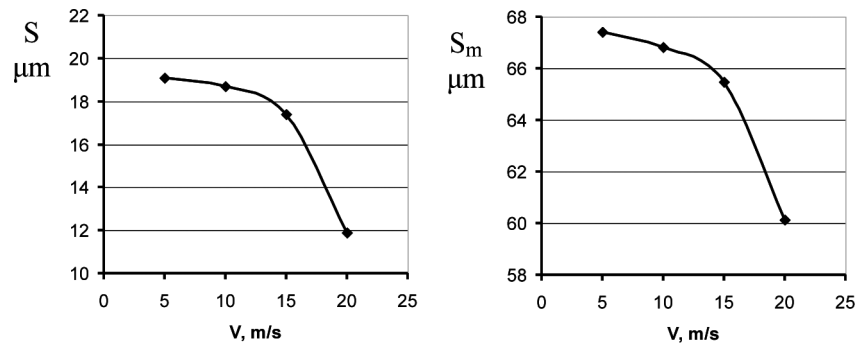

Fig. 9. The changing of value of of the horizontal parameters of the surface roughness of wires of diameters of $\varphi 1.6$ mm drawn in drawing speed function

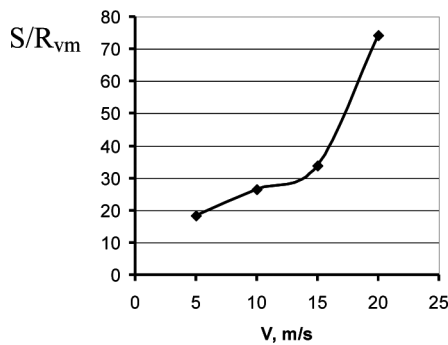

Fig. 10. Changing of values of Newman's ratio, S/R_{vm} , of the surface roughness of wires of diameters of $\varphi 1.6$ mm in drawing speed function

From the data in Fig. 7 it can be found that drawing speed influences the profile height parameters. The wires from Variant D ($V_c=20$ m/s), as compared to the wires from variant A ($V_c=5$ m/s), have definitely lower surface roughness, which is also evidenced by the smaller values of R_p , R_v , R_t , R_{pm} , R_{vm} . The differences between Variants A and D range from 74 to 85 %. It is found that low values of the profile height parameters, and particularly the defect depth R_{vm} , for wires drawn at high speeds (Variant D) may positively influence the wire fatigue strength.

For the profile deviation parameter, R_a , R_q , R_{sk} , the value of these parameters decreases with increasing drawing speed. These parameters for the wires from Variant D are from 39% to 77% smaller compared to the A Variant wires (Fig. 8).

From the data represented in Fig. 9 it is found that for the horizontal parameters the wires drawn at high drawing speeds have a smaller distance between adjacent profile hills.

The data in Fig. 10 shows that the wire drawn at high drawing speeds are distinguished by greater Newman's ratio. The differences between the extreme variants, i.e. A and D, amounted to above 300%. Higher Newman's ratio values are indicative of lower susceptibility to crack initiation in the sub-surface layers of wires drawn at high

drawing speeds. This, in turn, leads to an increase in their fatigue strength.

5. Numerical analysis of the drawing process

The group of factors influencing the fatigue strength of wire includes the hardening of the sub-surface layer, which is the sum of the homogeneous strain resulting from the cross-section reduction and the redundant strain that increases the strain inhomogeneity. The maximum redundant strain values occur in sub-surface layers, while in the wire axis they are close to zero; hence, in the study, the redundant strains were determined on the wire surface.

The experimental determination of the distribution of redundant strain over the drawn wire cross-section is difficult to accomplish; therefore a theoretical analysis of this problem based on the software program Drawing 2D [8] is put forward in the article. Simulation of the multi-stage drawing process was performed for wire of pearlitic-ferritic steel C75 ($\sim 0.75\%C$) with the single reduction of area, the reduction of area and the drawing speeds shown in Tables 2÷3. Depending on the drawing speed, the following friction coefficient were assumed: 0.065; 0.067; 0.075; 0.09 (the friction coefficient values were taken from study [3]).

In the visualization of distribution of a particular parameter, the Drawing 2D program provides the capability to read out the numerical value of that parameter for each of the triangular grid nodes, which enables the distributions of redundant strain over the cross-section of wires upon exit from the drawing die sizing part to be determined. Figure 11 presents an example redundant strain distribution over the cross-section of 1.6 mm wired drawn according to Variant B. While Figure 12 shows the distribution of redundant strain over the wire surface depending on the total reduction in area and drawing speed.

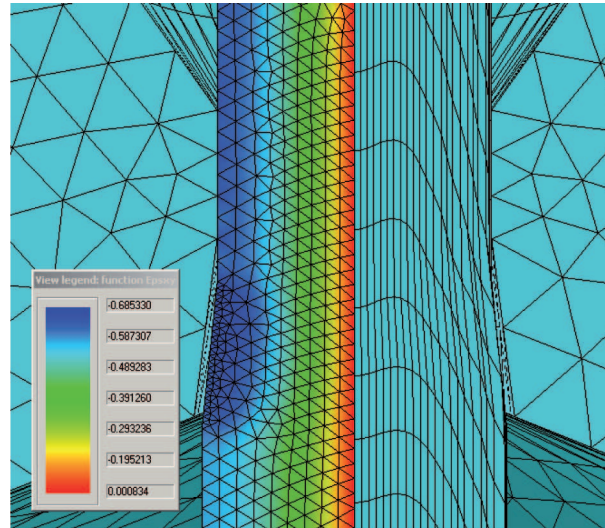

Fig. 11. The distribution of redundant strain of 1,6 mm diameter wires drawn according to variant B

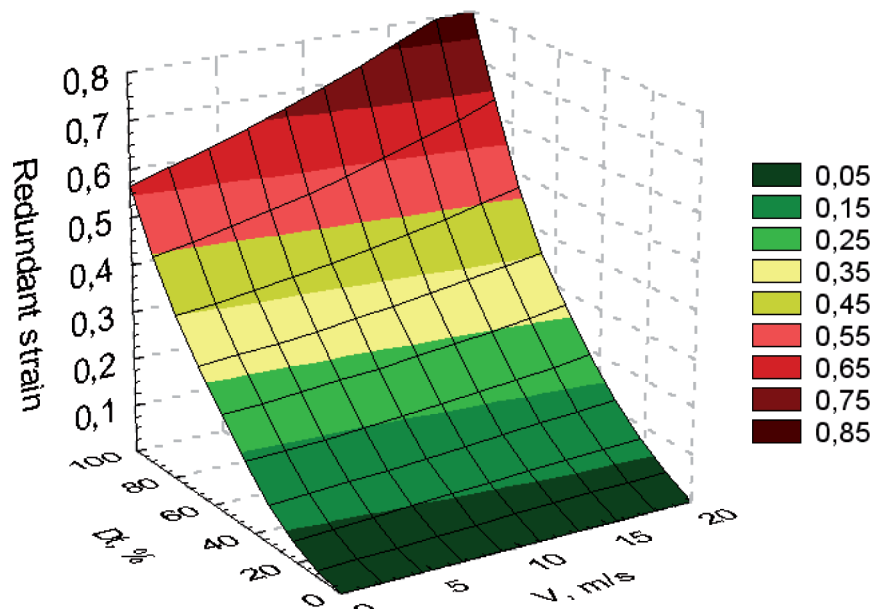

Fig. 12. The distribution of redundant strain ε_{xy} on the surface of wires in total reduction of area and drawing speed function

From the data shown in Fig. 12 it can be found that using high drawing speed (above 15 m/s) in the high-carbon steel wire drawing process causes a significant increase in redundant strain on the wire surface. Up to a total reduction of approx. $Dt=80\%$, the difference between the drawing variants examined amount to around 20%. While with a total reduction of area of $Dt=91\%$, these differences are much larger. The sub-surface layers in the Variant D wires exhibit a redundant strain larger by approx. 41% compared to the wires from Variant A. Obviously, such a large redundant strain increase in the wires drawn according to Variant D ($V=20$ m/s) should be associated with the impairment of lubrication conditions.

Larger redundant strain values in wires drawn at high speeds indicate higher material hardening. As a consequence, more hardened subs-surface layers of wires drawn at high speeds should be distinguished by definitely better resistance to the action of variable bending stresses.

6. Findings and conclusions

The investigations carried out have led to the following findings and conclusions:

1. High drawing speed markedly influences the fatigue strength of high-carbon steel wires. Wires drawn with the drawing speed of 20 m/s exhibit much,

- i.e. by approx. 80%, higher temporal fatigue strength compared to wires drawn with the drawing speed of 5 m/s.
2. The tests carried out have demonstrated that drawing high-carbon steel wires with high drawing speeds results in a decrease in the surface roughness (smoothing of the drawn wire surface). The Variant D wires show profile height parameters (R_p , R_v , R_t , R_{pm}) lower by 74 to 85% and profile deviation parameters (R_a , R_q , R_{sk}) lower by 39 to 77% compared to the wires from Variant A.
 3. The increase in drawing speed (notably above 15 m/s) not only causes a decrease in roughness parameters, but also results in the formation of a surface defect configuration such that delays the initiation of micro-cracks. Higher Newman's ratio values are indicative of lower susceptibility to crack initiation in the sub-surface layers of wires drawn with high drawing speeds.
 4. It has been found that the distinct surface smoothing of wires drawn at the speed of 20 m/s is likely to be associated with poorer lubrication conditions in the drawing process. In the wire regions, where only partial separation of the surface with a lubricant layer has taken place, wire surface tops are shorn, which leads to a decrease in surface roughness.
 5. The sub-surface layers in the wires from Variant D ($V=20$ m/s) exhibit a redundant strain larger by approx. 40% compared to the wires from Variant A ($V=5$ m/s). As a consequence, the more hardened sub-surface layers of wires drawn with high drawing speeds should be characterized by better resistance to the action of variable bending stresses, thus contributing to an increase in the fatigue strength of wires, specifically those from Variant D ($V=20$ m/s).
 6. The definitely higher fatigue strength of high-carbon steel wires drawn with high drawing speeds should make for increasing the fatigue life of hoisting ropes.
 7. The obtained investigation results could be utilized in the wire drawing industry in the implementation of new technologies for high-speed drawing of high-carbon steel wires.

REFERENCES

- [1] O. Pawełski, H. Vollmer, Thermische Simulation des Einflusses der Ziehgeschwindigkeit auf die mechanischen Eigenschaften gezogener Stahldrähte, Arch. Eisenhüttenw **47**, 1, 9-13 (1976).
- [2] M. Suliga, The influence of the high drawing speed on mechanical-technological properties of high carbon steel wires, Archives of Metallurgy and Materials, Quarterly **56**, 3, Warszawa-Kraków, 823-828 (2011).
- [3] M. Suliga, The influence of drawing speed on multi-pass drawing process of high carbon steel wires, Metallurgist-Metallurgical News (Hutnik-Wiadomości Hutnicze) **1**, 132-135 (2011).
- [4] J. Łuksza, A. Skołyśzewski, F. Witek, W. Zachariasz, Druty ze stali i stopów specjalnych, Wydawnictwo Naukowo-Techniczne, Warszawa (2006).
- [5] B. Goliś, J.W. Pilarczyk, Druty stalowe. Metalurgia Nr 35, Politechnika Częstochowska, Częstochowa (2003).
- [6] Z. Muskalski, Analiza wpływu kierunku ciągnięcia drutów na ich wytrzymałość zmęczeniową i trwałość zmęczeniową lin stalowych, Seria Metalurgia nr 43, Politechnika Częstochowska, Częstochowa (2004).
- [7] M. Suliga, The influence of the multipass drawing process in classical and hydrodynamic dies on residual stresses of high carbon steel wires, Archives of Metallurgy and Materials Quarterly **56**, 4, Warszawa-Kraków, 939-944 (2011).
- [8] A.A. Milenin, B.P.B. Gautham, S.C. Goyal, J. Pilarczyk, Z. Muskalski, FEM simulation of wire fracture phenomena during multi-pass drawing, Wire Journal International, 93-99, October (2008).